

COOKS

professional



7L Stand Mixer Instruction Manual

Product Code: K598 • K599 • K600 • K601 • K760 • K903 • K1035

After Sales Support
care@cooksprofessional.co.uk

For correct usage, please read these instructions carefully before use and keep in a safe place for future reference.

REGISTER NOW FOR EXTENDED 2-YEAR WARRANTY

When you buy direct from the Cooks Professional website your free 2-year warranty is automatically applied upon purchase (no further action required).

If you purchased your product through a different retailer website you can register your product for an extended 2-year warranty by visiting www.cooksprofessional.co.uk/extended-warranty or scan the QR code.



COOKS

professional

Introduction

Congratulations

You have made an excellent choice with the purchase of this quality Cooks Professional product.

By doing so you now have the assurance and peace of mind which comes from purchasing a product that has been manufactured to the highest standards, performance and safety.

We want you to be completely satisfied with your purchase, so this Cooks Professional product is backed by our full 12 month manufacturer's guarantee and an outstanding after sales service through our dedicated Helpline.

We hope you enjoy using your purchase for many years to come.



General information and safety warnings

- Use this appliance only in accordance with the instructions.
- Before plugging into the mains power supply, check the domestic voltage corresponds to the rating label of the appliance.
- This appliance must never be operated via an external or separate remote-control system.
- Always use the original power cable supplied with the appliance.
- The use of accessory attachments that are not recommended by the manufacturer may cause injuries.
- Always remove the plug from the mains power supply before assembling or disassembling, cleaning or storing or if the appliance malfunctions.
- Make sure that the power cable and plug do not come into contact with water.
- Make sure that your hands are dry when you touch the appliance, the power cable or the plug.
- Do not immerse the cord, plug or appliance motor unit in any liquid.
- Never place the appliance on or near a warm hotplate or other source of heat.
- Place the appliance on a flat, stable, heat-resistant and splash-proof surface where it cannot fall.
- Never move the appliance when it is switched on.
- To prevent anyone from tripping over the power cable, make sure that it is not draped over the worktop.
- Do not use appliance for anything other than the intended use.
- Do not use outdoors or for commercial purposes.
- Avoid contact with any moving parts.
- Never use a damaged appliance. If the power cable is damaged or your appliance has malfunctioned, please take it to your local electrical store for repair. The appliance should only be repaired by a qualified technician, never try to repair it yourself.
- This appliance is not intended for use by persons (including children) with reduced physical, sensory or mental capabilities, or lack of experience and knowledge, unless they have been given supervision or instruction concerning use by a person responsible for their safety.
- Children should be supervised to ensure that they do not play with the appliance.
- Never leave the appliance unattended when in use.

- Keep hands and utensils away from moving parts while processing food to reduce the risk of severe injury to yourself or others. This should also ensure the appliance remains undamaged.
- Never attempt to take food or liquid out from the bowl or other attachments when parts of the appliance are moving. Always wait until the motor stops completely.
- Do not overload the appliance with food.
- To prevent the risk of fire, the appliance needs space to allow heat to escape. Make sure that the appliance has sufficient space around it and does not come into contact with flammable materials. The appliance must not be covered.

Before first use

Clean the appliance thoroughly; clean the beater, whisk, dough hook and mixing bowl in a mild detergent solution, rinse and dry thoroughly.

Note:

- When this appliance is switched on for the first time, you may detect an unusual odour. This is quite normal and will disappear after a few minutes of use.
- To avoid unnecessary strain or overloading on the motor, do not use the mixer for any mixture that does not allow the beater/whisk/dough hook to revolve freely.

Description of parts

- | | |
|-------------------------|-----------------|
| 1. Output Shaft | 5. Dough Hook |
| 2. Open/Close Lever | 6. Flat Beater |
| 3. Speed Control Dial | 7. Whisk |
| 4. Stainless Steel Bowl | 8. Splash Guard |

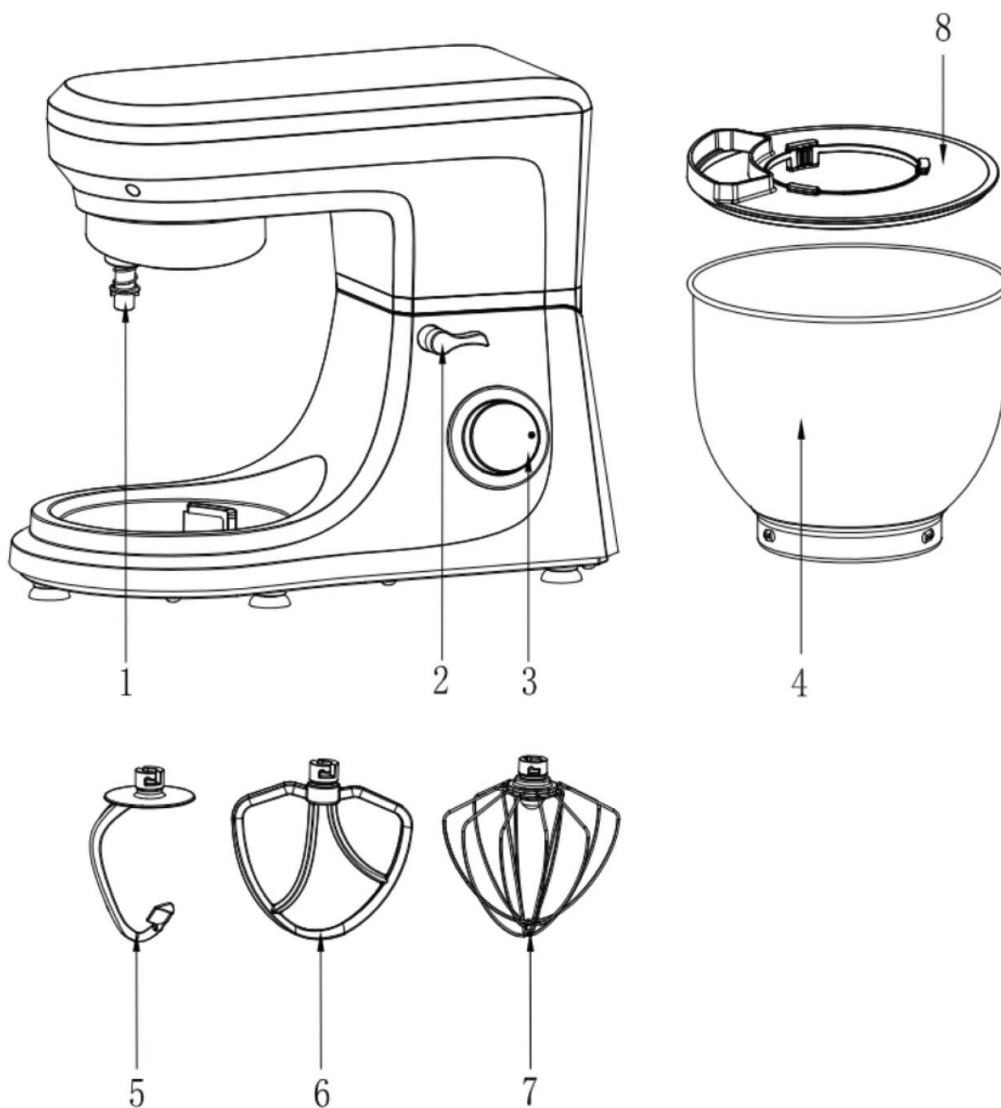

Instructions for use

- Before attaching the bowl, flat beater, whisk or dough hook, ensure the mixer is unplugged from the mains power supply.
- Push the mixer head lever downwards and at the same time tilt the mixer head back.
- Attach the bowl by placing it in position and gently turn clockwise until it locks into place.
- Attach the flat beater, whisk or dough hook by inserting onto the two raised notches on the underside of the mixer head; turn clockwise until it locks into place.
- The splatter guard sits on the top of the bowl during use.

Mixer accessories

- **Flat Beater** – Use for normal to heavy mixtures: Cakes, biscuits, creamed icing, quick breads, mashed potato and pie pastry.
- **Whisk** – Use for mixtures that need air incorporated: Eggs, egg whites, heavy cream, sponge cake, mayonnaise.
- **Dough Hook** – Use for mixing and kneading yeast dough: Breads, rolls and buns.

Speed control

The speed control dial should be set to the lowest speed for starting and then gradually move to the desired higher speed to avoid splashing ingredients out of the bowl.

Note: Using the pulse settings allows for greater control over the texture of the food produced. It is only intended to be used for short bursts of mixing.

- P – Pulse.
- 0 – Off.
- 1 – Slow stirring, combining, mashing and starting all mixing.
- 2 – Slow mixing batters and dough, mashing and faster stirring.
- 3 – Mixing batters and dough.
- 4 – Medium-fast beating or whipping.
- 5 – Whipping cream, egg whites.
- 6 to 8 – Whipping small amounts of cream or egg whites.



Note: Do not exceed speed 3 when preparing dough. This may damage the mixer. The maximum weight of dough that can be mixed at a time is 1.5kg.

Mixing

- Most recipes provide the required time and speed needed for correct mixing.
- Always add ingredients as close to the side of the bowl as possible, not directly in to the moving beater.
- Place the ingredients into the mixing bowl; push the motor head down until it locks into position.
- Select speed setting 1 the attachment will rotate automatically. As the ingredients become combined the speed can be increased. To ensure that all ingredients are thoroughly mixed, you can use a plastic or wooden spatula (not included) to scrape the sides of the mixing bowl.
- To prevent splattering, keep the beaters in the mixture and **always** switch the mixer off before lifting the beaters from the mixture.
- When you have finished the mixing operation, set the control dial to '0', remove from the mains supply socket, press the motor head locking button then push the mixer until it locks into the upper position. Eject the beater etc. by turning the beater anticlockwise.

Care and maintenance

Wash all detachable parts in hot soapy water and dry thoroughly.

Wipe the body of the stand mixer with a soft damp cloth and dry thoroughly.

IMPORTANT! Dry fully after cleaning before using again. Do not use the appliance if it is damp.

- After washing and drying, store the appliance with its accessories in a dry, safe place out of the reach of children.

Example run times when using the mixer.

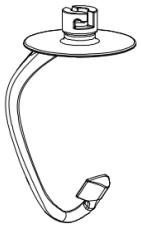
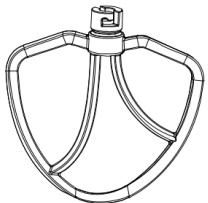
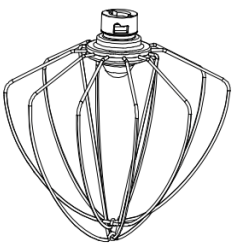
Accessories	Picture	Speed	Maximum ingredients	How to mix:
Dough hook		1-3	1000g flour+538g water	Speed 1 for 30 seconds Speed 2 for 30 seconds Speed 3 for 2 – 4 minutes
Flat Beater		2-5	660g flour+840g water	Speed 2 for 20 seconds Speed 5 for 2 – 3 minutes
Whisk		5-6	3 egg whites (min)	Speed 5 to 6 for 3+ minutes



Plug Wiring

These safety instructions should be read carefully and kept in safe place for future reference.

This appliance is fitted with a plug that complies with BS 1363. Only high quality 13A (square pin) plugs that comply with this standard should be fitted.

Wires are coloured as follows:

Brown – Live

Blue – Neutral

Yellow & Green – Earth

If the appliance is fitted with a 2-core cable it is double insulated and will not have the yellow and green earth wire.

IT IS ESSENTIAL THAT WIRES ARE ATTACHED ONLY TO THEIR DESIGNATED POSITIONS IN THE PLUG

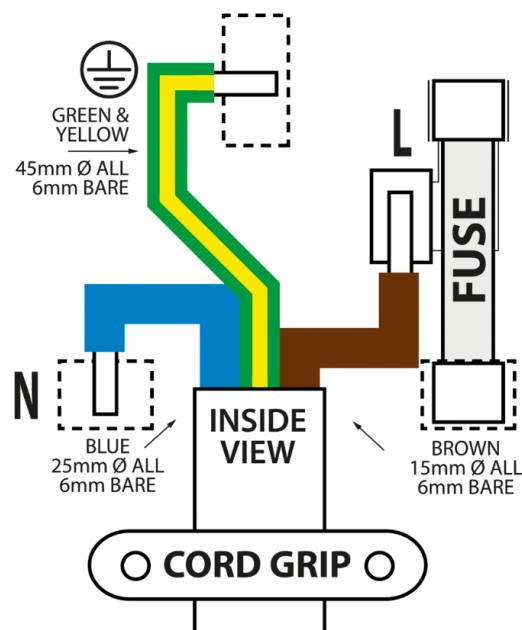

Fuses must be replaced with the same rating as the original; please refer to the fuse rating stated on the plug for this information. Only genuine fuses compliant with BS 1362 should be used.

GUARANTEE IMPORTANT

Please do not return this product without first emailing our Customer Services at:

care@cooksprofessional.co.uk

Thank you for purchasing this product, which has been made to demanding high quality standards and is guaranteed for domestic use against manufacturing faults for a period of 12 months from the date of purchase.

This guarantee does not affect your statutory rights. If your product fails due to a defect in material or workmanship during this period, please return it to the place of purchase. Normal wear and tear is not covered under the guarantee. Any guarantee is invalid if the product has been misused or subject to neglect or an attempted repair other than by our own service centre. Due to continuous product improvement, we reserve the right to change the product specification without prior notice.

EXTENDED 2 YEAR WARRANTY

WHEN YOU BUY DIRECT FROM THE COOKS PROFESSIONAL WEBSITE YOUR FREE 2 YEAR WARRANTY IS AUTOMATICALLY APPLIED UPON PURCHASE.

If you purchased your product through a different retailer you can register your product for an extended 2-year warranty by visiting our website www.cooksprofessional.co.uk/extended-warranty. The product must be registered, along with your contact information, within 14 days of purchase.

For full terms and conditions please visit our website.

E-mail: care@cooksprofessional.co.uk

Please retain for future reference.
Colours and contents may vary.

Waste electrical products should not be disposed of with household waste. Please recycle where facilities exist. Check with your Local Authority or retailer for recycling advice.

Please note that all products with the symbol below must be recycled.

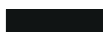

COOKS PROFESSIONAL 'HELP CENTRE'

Welcome to the Cooks Professional 'Product Help' resource centre!

Visit the Cooks Professional website and search for the product you need help with. At the bottom of the product page you'll find the 'Product Help' section.

Here, you'll find all the resources you need to make the most of your Cooks Professional products. Our online 'Product Help' resources are continually being updated with the latest product manuals, 'How to Use' and 'Hints & Tips' videos. Whether you're a first-time user or a seasoned cook, we have something for everyone.

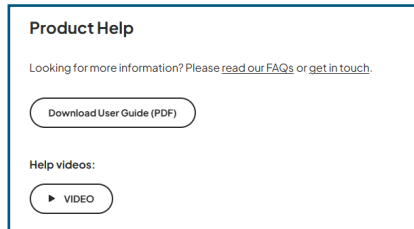

Features:

Latest Product Manuals: Access up-to-date manuals for all our products.



How to Use Videos: Step-by-step guides to help you get started.

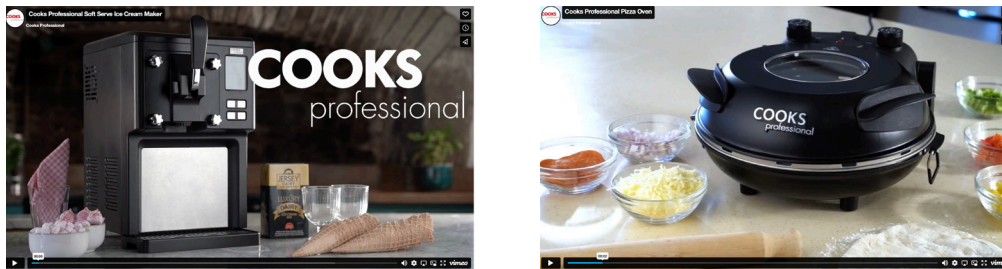

Hints & Tips Videos: Expert advice and creative ideas to enhance your cooking experience.

Visit us today and explore our comprehensive collection of resources. If you have any questions, our Customer Care team is available to assist you via Live Chat, email, or our contact form.

Scan here



cooksprofessional.co.uk



Share your purchase with us on social media and tag
@cooksprofessional to be featured!

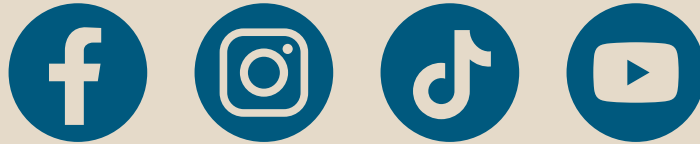

We'd like to know what you think!

We'd be very grateful if you can spare a few minutes to leave us a review.
Please review on the retailer website where you placed your order.

Need help?

Our friendly customer care team work Monday to Friday.
Message us at:

care@cooksprofessional.co.uk



Follow us on Instagram

**7L Stand Mixer
K598 • K599 • K600 • K601 • K760 • K903 • K1035 Instruction Manual**

For correct usage, please read these instructions carefully
before use and keep in a safe place for future reference.